

# Sistema K1 / K1 System

Sistema a parete composto da montanti, ripiani e accessori per la realizzazione di librerie, cabine armadio ed espositori. I montanti sono forniti in 5 diverse altezze da 57 cm fino a 249 cm; i fori sono realizzati in modo da consentire il posizionamento dei ripiani ogni 6 cm circa a partire da 18 cm (18, 24, 36, ... cm). I ripiani e i contenitori hanno quattro larghezze: 40, 60, 75.5 e 90 cm. Sono disponibili tre finiture: alluminio anodizzato naturale, bianco e nero opaco. A richiesta sono disponibili altri colori e tagli speciali sia per i ripiani che per i montanti.

Wall System composed by uprights, shelves and accessories to make bookcases, wardrobes and exhibitors. The uprights are provided in 5 different heights from 57 cm to 249 cm; the holes in it are made to allow the positioning of the shelves each 6 cm approximately from 18 cm (18, 24, 36, ... cm). The shelves and containers are available in four standard widths: 40, 60, 75 and 90 cm. There are three finishes too: anodized aluminum, white (RAL 9010) and mat black. Other colors and special cuts for the shelves to the uprights are even available under request.

Libreria / Bookshelv



Guardaroba / Wardrobe



## FINITURE / FINISHINGS

-  Alluminio anodizzato / Anodized aluminium
-  Bianco lucido RAL 9010 / White bright RAL
-  Nero opaco RAL 9005 / Mat Black RAL 9005

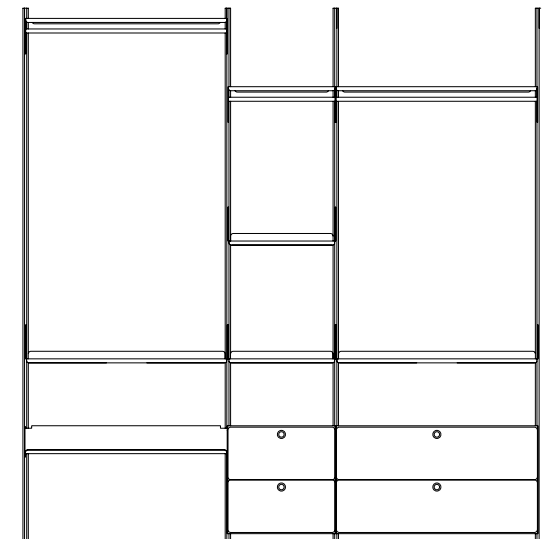

# Sistema K1 / K1 System

## Montanti / Uprights

**INGOMBRO:** Per calcolare la larghezza della struttura, considerare sempre 2 cm di ingombro dei montanti esterni (1 cm + 1 cm)  
**OVERALL:** To calculate the width of the structure, always consider 2 cm of space outside of the uprights (1 cm + 1 cm)

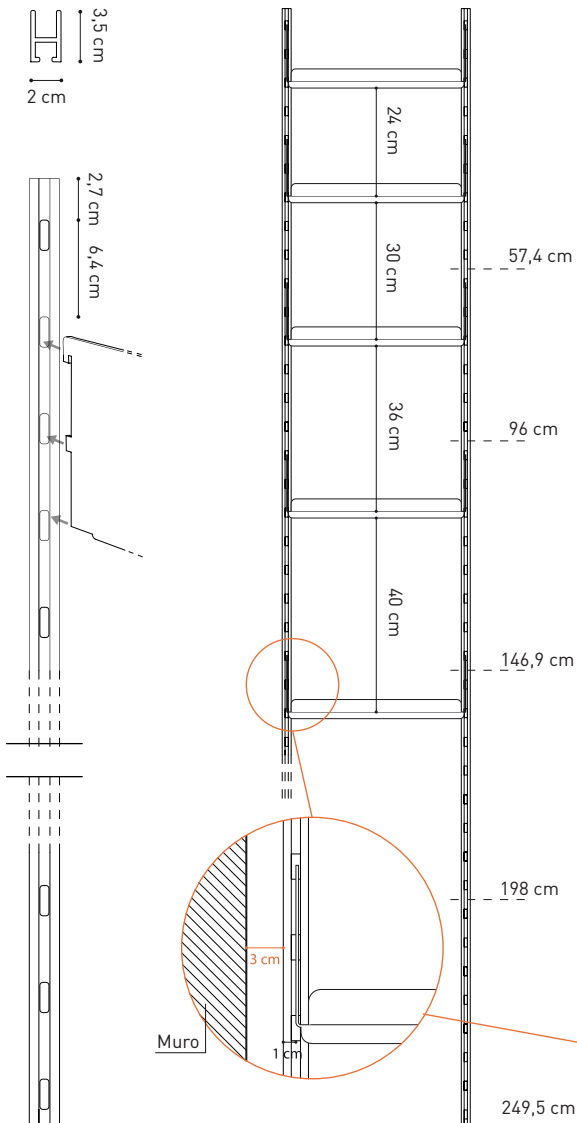

Lasciare sempre min. 3 cm tra le pareti laterali e i montanti esterni della struttura  
 Always leave min. 3 cm between the side wall and the first upright of the structure

## Ripiano Semplice / Basic shelf

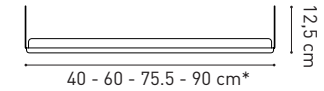

\* Disponibili solo le profondità 18,5 e 29,5 cm  
 \* Available just with depth of 18.5 e 29.5

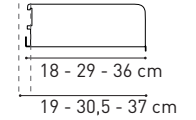

## Ripiano appendieria / Shelf with hanger

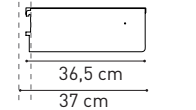
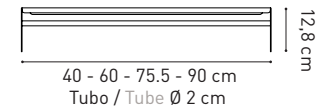

## Ripiano profondo / Deep shelf

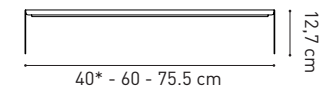

\* Disponibile solo con profondità 44.5 cm  
 \* Available just with depth of 44.5

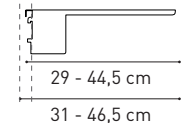

## Ripiano inclinato / Inclined shelf

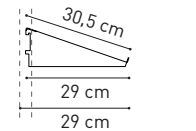
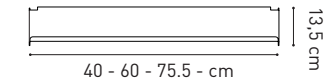

## Reggipiani / Shelf Holders

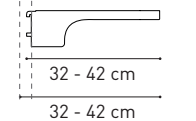
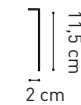

## Piedino / Foot

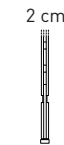
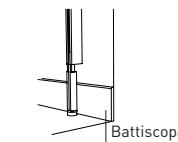

## Montante corto per cassettiere / Short upright for chest of drawer

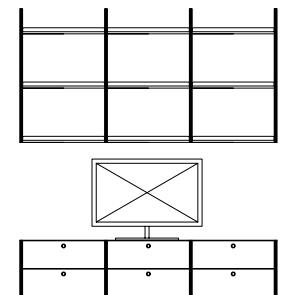
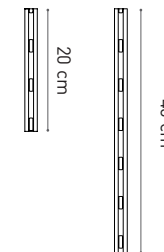
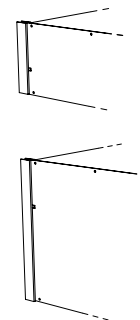

# Sistema K1 / K1 System

www.kryptonite.com

Cassettiera singola /  
Chest of drawer

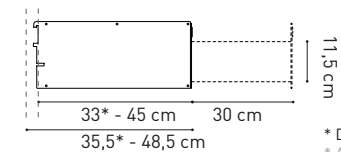
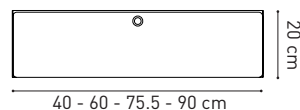
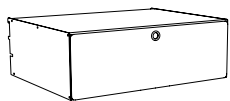

\* Disponibile solo per la larghezza 60 cm  
\* Available just in width 60 cm

Cassettiera doppia /  
Double chest of drawer

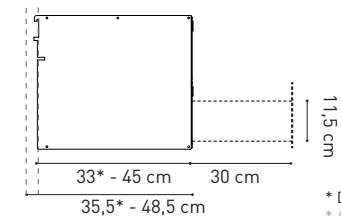
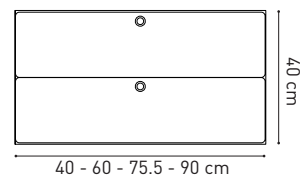
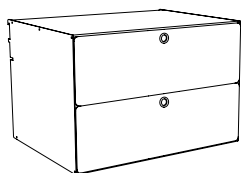

\* Disponibile solo per la larghezza 60 cm  
\* Available just in width 60 cm

Ribaltina apertura dall'alto /  
Hanged Tip-up panel open from  
the top

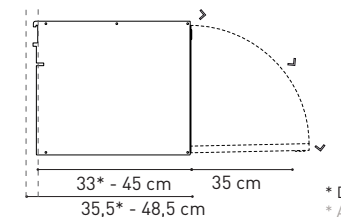
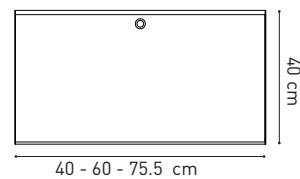
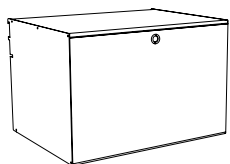

\* Disponibile solo per la larghezza 60 cm  
\* Available just in width 60 cm

Ribaltina apertura dal basso /  
Hanged Tip-up panel open from  
the bottom

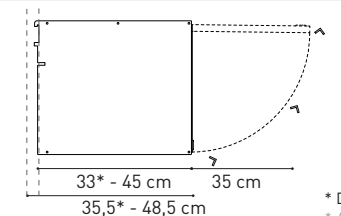
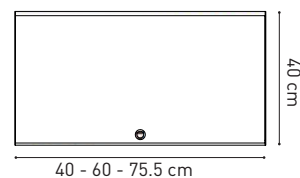
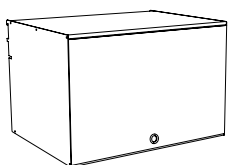

\* Disponibile solo per la larghezza 60 cm  
\* Available just in width 60 cm

Cassettone /  
Chest of drawer

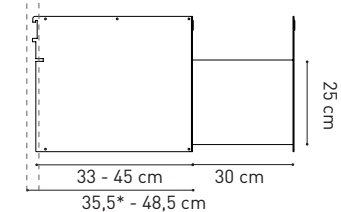
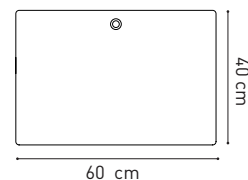
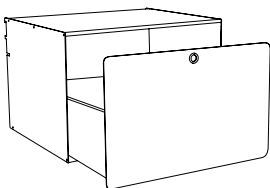

Cassettone portaschedari /  
Chest of drawer card file

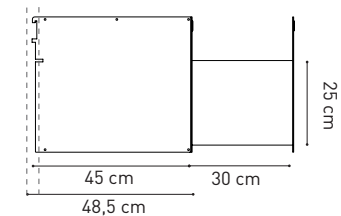
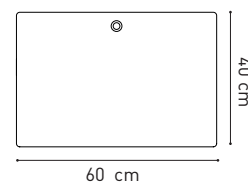
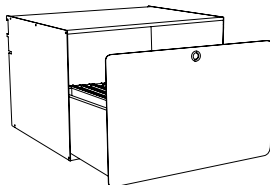

## CAPENZA / CAPACITY

Cassettiera singola /  
Chest of drawer

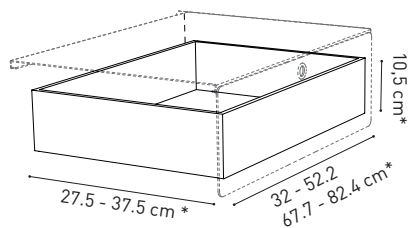

\* Ingombro interno

Cassettone /  
Chest of drawer

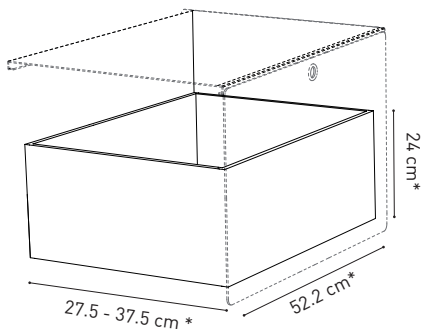

\* Ingombro interno

Ribaltina /  
Hanged Tip-up panel

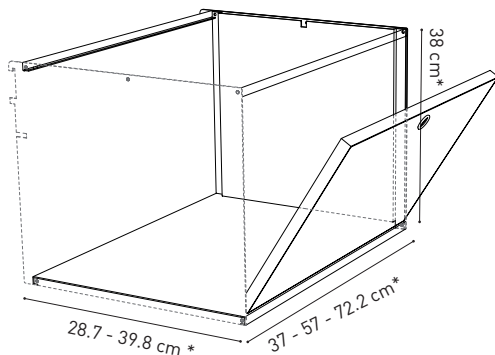

\* Ingombro interno

## AGGANCI / HOOKS

Cassettiera singola /  
Chest of drawer

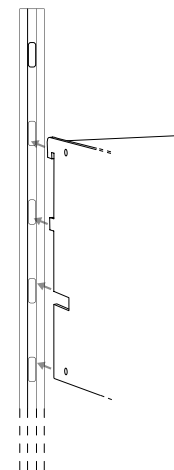

Cassettiera doppia,  
ribaltina e cassettone /  
double chest of drawer,  
hanged tip-up panel, chest  
of drawer

